

ITL DENTAL Implant Catalog



ITL DENTAL

Implant System Catalog

ITL Dental was established in 1991 and is a manufacturer of dental implants and dental implant accessories. The Company has supplied dental implants and dental implant products to a number of leading implant system companies on a world-wide basis. Products are manufactured under a quality management system that complies with the requirements of ISO 13485: 2016, has FDA 510K, CE and MD Sap Certification.

Pricing for the products is based upon the purchase order quantity. Dental implants and abutments are sold as Private Label products. Dental implant accessories are sold as brand products or Private Label products.

This catalog displays a sampling of our implant products. Please contact us to discuss how we can meet your implant product needs.

ITL DENTAL

ITL DENTAL Implant Catalog

Internal Hex Implants

Six Implant Diameters: 1.

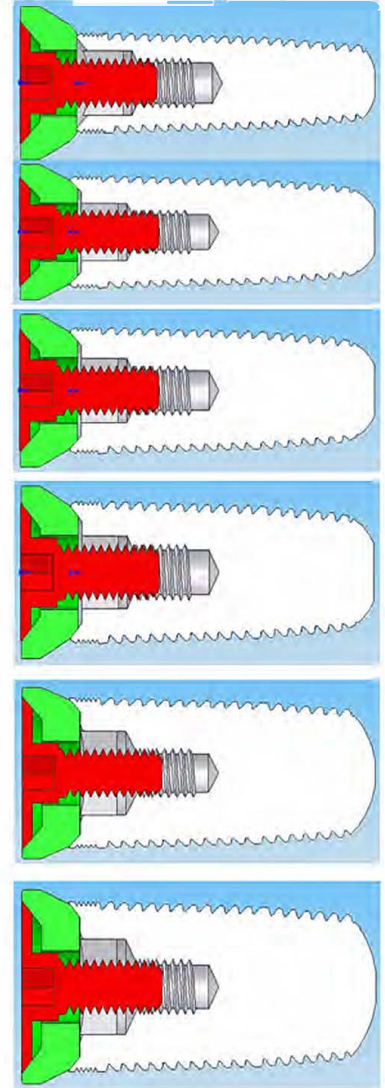
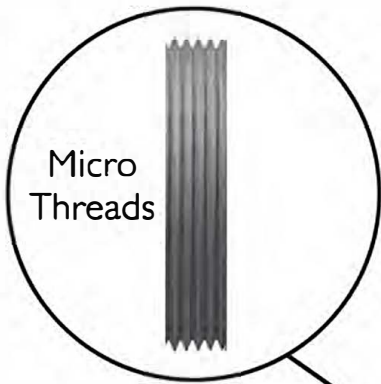
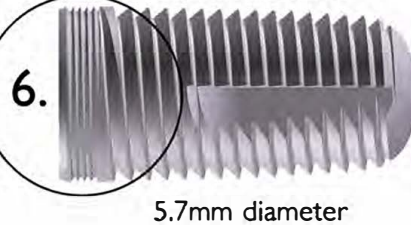
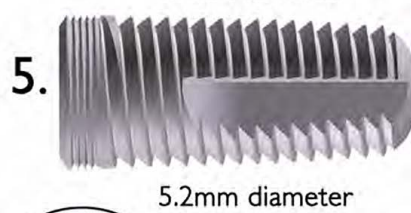
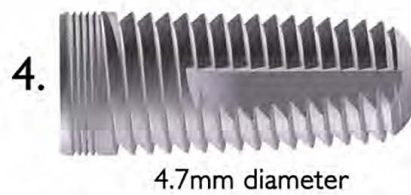
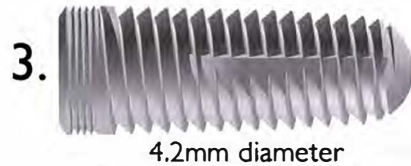

Five Internal Hex Implant Lengths



(Above renderings not to scale) Implants continued on next page...

ITL DENTAL

Internal Hex Implants

Internal Hex Implants

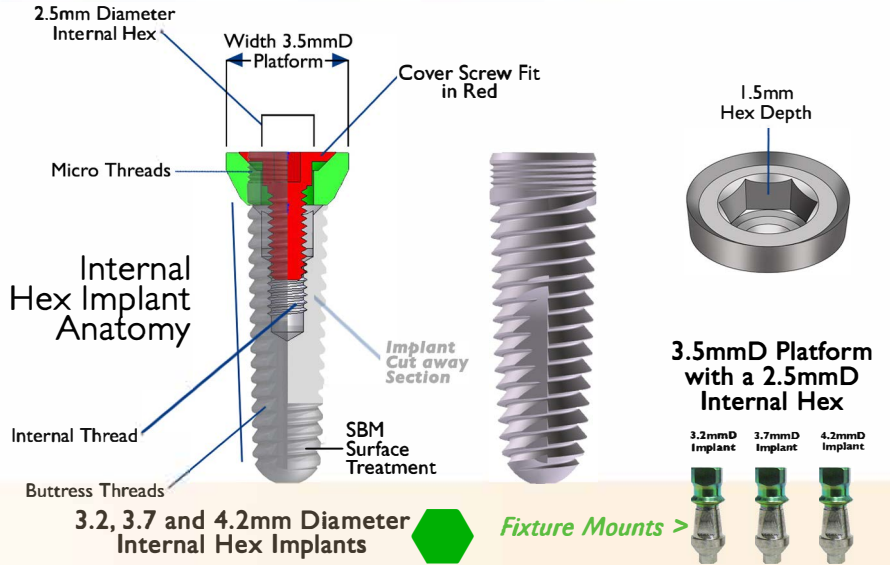

**Color-coded
Fixture Mounts
that can also be
used as transfers.**

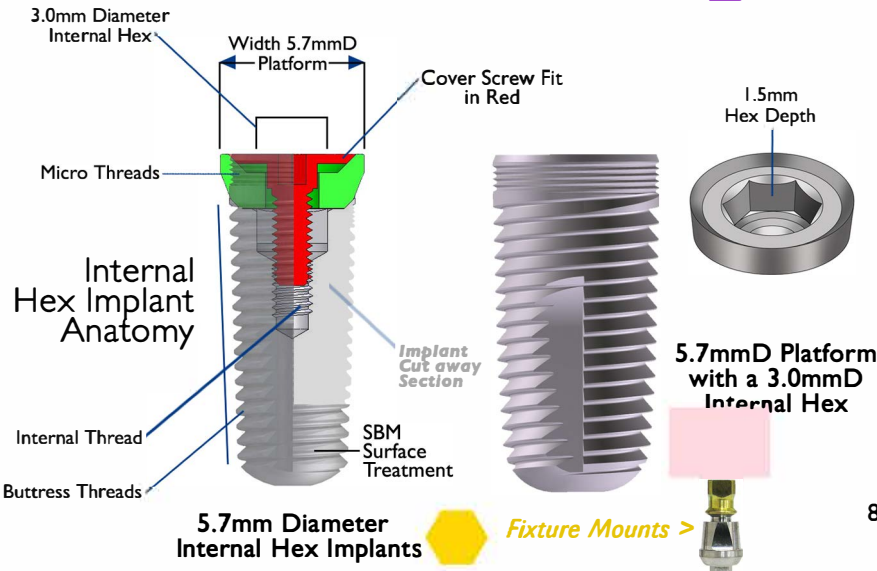
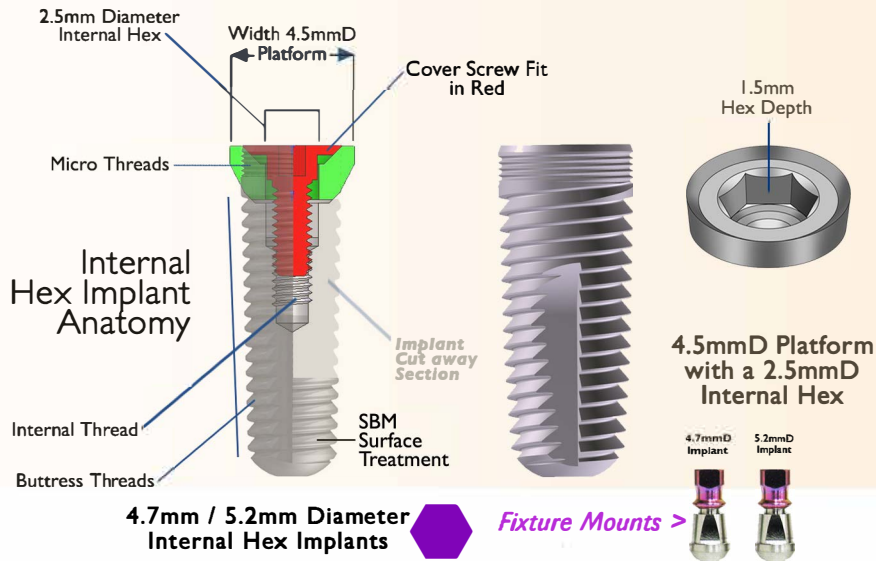

(Above renderings not to scale)

ITL DENTAL Implant Catalog

Internal Hex Implant Packaging

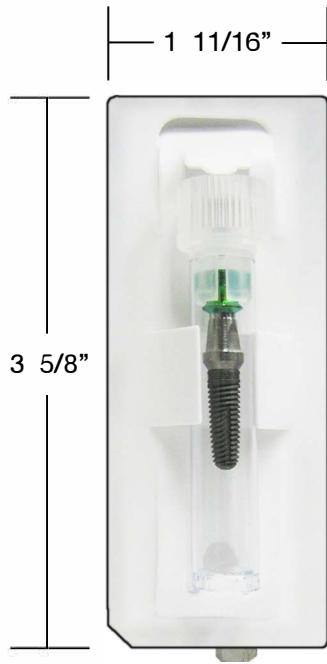

Mount Options Shown Below

Cervical
Contoured Mount
Option

Standard
Mount
Option



Product
Code: IHXXXXA

IHXXXX

(See Page 8)

(Backside of Sleeve shown below)

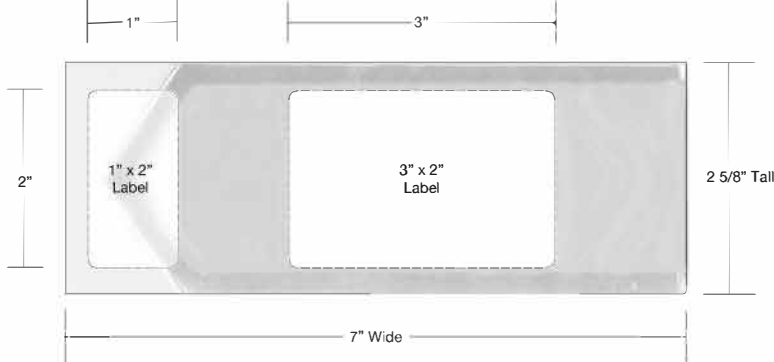

(Above photos not to scale)

ITL DENTAL

Internal Hex Implant

The Internal Hex Implant from ITL DENTAL
with 45 degree internal bevel

2.5 mm internal hex.

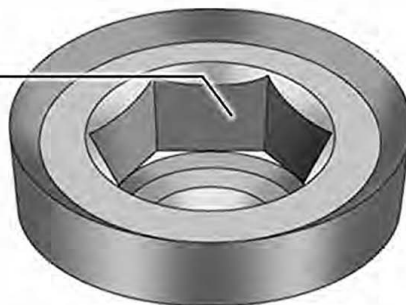

Micro-grooves for enhanced tissue attachment. Micro-threads for increased stability and crestal bone stress reduction.

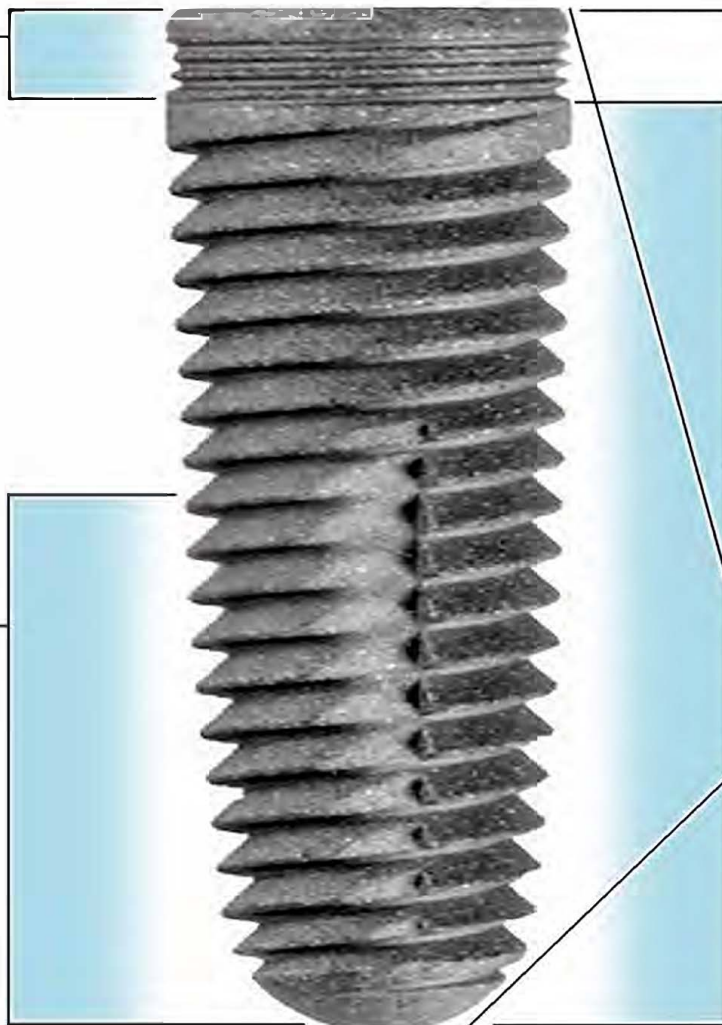

Tapered lead-in seals opening at crestal ridge. Less need for bone grafting.

Double lead threads require reduced turns for insertion. Vertical self-tapping grooves.

Tapered body decreases compression and increases initial stabilization. Helps self-tapping insertion in dense bone.

SBM Surface Treatment for increased surface contact area. Greater bone to implant contact.

Rounded apex for accurate implant insertion. Reduces risk of sinus perforation.

ITL DENTAL

Implant Catalog

Wide-Pitch Thread Internal Hex Implants

Five Implant Diameters:

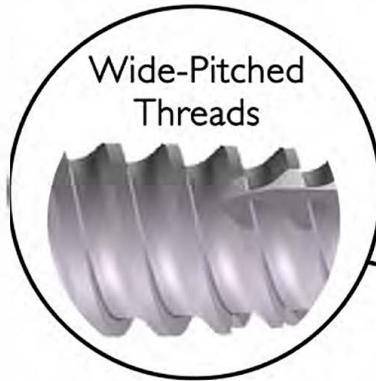

1. 3.2mm diameter
2. 3.7mm diameter
3. 4.2mm diameter
4. 4.7mm diameter
5. 5.2mm diameter



Five Internal Hex Implant Lengths



(Above renderings not to scale)

ITL DENTAL

ITL DENTAL Implant Catalog

The Single Platform (SP) Implant System

Five implant diameters
with a 3.5mm platform:



3.2



3.7



4.2



4.7



5.2mm

- Platform switching for the 4.2, 4.7 and 5.2mm implants.
- Available with Narrow-Pitch (NP) or Wide-Pitch (WP) threads.
- Fixture mount is for implant insertion and can be used as a transfer.

- Standard fixture mount.



- Cervical Contoured fixture mount.

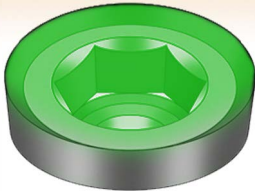

3.5mm Platform
Color: Green

Narrow-Pitch
Implant

Wide-Pitch
Implant

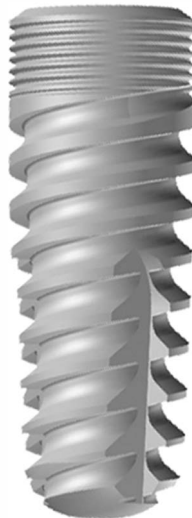
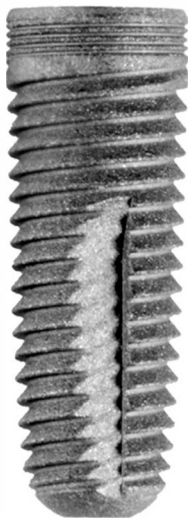

4.7 / 5.2 Implant Product Codes
with 3.5 Platform:

NP: IHPXXXX

WP: IHWPXXXX

with HA Coating

WP: IHAWPXXXXA

(Above photos not to scale)

ITL DENTAL

ITL DENTAL

Implant Catalog

Internal Hex Implant Product Codes

Diameter	Length	NP THREAD		WP THREAD		HA Coated WP Implants Cervical Contoured Mount
		Cervical Contoured Mount	Standard Mount	Cervical Contoured Mount	Standard Mount	
3.2mm (3.5 Platform)						
	8mm	IH328A	IH328	IHW328A	IHW328	IHAW328A
	10mm	IH3210A	IH3210	IHW3210A	IHW3210	IHAW3210A
	11.5mm	IH3211A	IH3211	IHW3211A	IHW3211	IHAW3211A
	13mm	IH3213A	IH3213	IHW3213A	IHW3213	IHAW3213A
	16mm	IH3216A	IH3216	IHW3216A	IHW3216	IHAW3216A
3.7mm (3.5 Platform)						
	8mm	IH378A	IH378	IHW378A	IHW378	IHAW378A
	10mm	IH3710A	IH3710	IHW3710A	IHW3710	IHAW3710A
	11.5mm	IH3711A	IH3711	IHW3711A	IHW3711	IHAW3711A
	13mm	IH3713A	IH3713	IHW3713A	IHW3713	IHAW3713A
	16mm	IH3716A	IH3716	IHW3716A	IHW3716	IHAW3716A
4.2mm (3.5 Platform)						
	8mm	IH428A	IH428	IHW428A	IHW428	IHAW428A
	10mm	IH4210A	IH4210	IHW4210A	IHW4210	IHAW4210A
	11.5mm	IH4211A	IH4211	IHW4211A	IHW4211	IHAW4211A
	13mm	IH4213A	IH4213	IHW4213A	IHW4213	IHAW4213A
	16mm	IH4216A	IH4216	IHW4216A	IHW4216	IHAW4216A
4.7mm (4.5 Platform)						
	8mm	IH478A	IH478	IHW478A	IHW478	IHAW478A
	10mm	IH4710A	IH4710	IHW4710A	IHW4710	IHAW4710A
	11.5mm	IH4711A	IH4711	IHW4711A	IHW4711	IHAW4711A
	13mm	IH4713A	IH4713	IHW4713A	IHW4713	IHAW4713A
	16mm	IH4716A	IH4716	IHW4716A	IHW4716	IHAW4716A
5.2mm (4.5 Platform)						
	8mm	IH528A	IH528	IHW528A	IHW528	IHAW528A
	10mm	IH5210A	IH5210	IHW5210A	IHW5210	IHAW5210A
	11.5mm	IH5211A	IH5211	IHW5211A	IHW5211	IHAW5211A
	13mm	IH5213A	IH5213	IHW5213A	IHW5213	IHAW5213A
	16mm	IH5216A	IH5216	IHW5216A	IHW5216	IHAW5216A
5.7mm (5.7 Platform)						
	8mm		IH578			
	10mm		IH5710			
	11.5mm		IH5711			
	13mm		IH5713			
	16mm		IH5716			

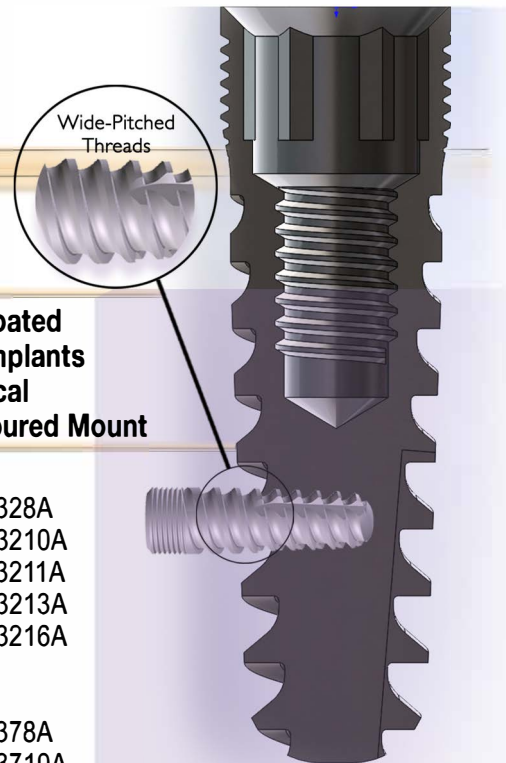

**5 Internal Hex
Implant Lengths**

16mm, 13mm, 11.5mm, 10mm and 8mm

4.7 / 5.2 Implants (3.5 Platform)

NP	WP	WP-HA
IHP478	IHWP478	IHAWP478A
IHP4710	IHWP4710	IHAWP4710A
IHP4711	IHWP4711	IHAWP4711A
IHP4713	IHWP4713	IHAWP4713A
IHP4716	IHWP4716	IHAWP4716A
IHP528	IHWP528	IHAWP528A
IHP5210	IHWP5210	IHAWP5210A
IHP5211	IHWP5211	IHAWP5211A
IHP5213	IHWP5213	IHAWP5213A
IHP5216	IHWP5216	IHAWP5216A

NP + WP - Standard Mount
WP - HA - Cervical Contoured Mount

Implant Instrumentation

SURGICAL DRILLS

The step drills are coated to improve the visualization of the score lines and to increase cutting lubricity. They are available in 7 diameters. The first 4mm is the smaller diameter stepping up to the larger diameter.



16mm
13mm
11.5mm
10mm
8mm



With Hub Drill for Drill Stops



No Hub Drill



LMD 18 Pilot Drill PDT White 2320 Grey 2823 Green 3428 Pink 3834 Purple 4438 Blue 4844 Yellow 5448

13mm STP13
11.5mm STP115
10mm STP10
8mm STP08 Drill Stops

Drill Sequence Chart

Drill Code*	Drill Code No Hub	Size	Color	Platform/Implant Diameter					
				3.5/3.2	3.5/3.7	3.5/4.2	4.5/4.7	4.5/5.2	5.7/5.7
SD2320	SDS2320	2.3/2.0	White	X	X	X	X	X	X
SD2823	SDS2823	2.8/2.3	Grey	X	X	X	X	X	X
SD3428	SDS3428	3.4/2.8	Green		X	X	X	X	X
SD3834	SDS3834	3.8/3.4	Pink			X	X	X	X
SD4438	SDS4438	4.4/3.8	Purple				X	X	X
SD4844	SDS4844	4.8/4.4	Blue					X	X
SD5448	SDS5448	5.4/4.8	Yellow						X

Last drill is used in dense bone situations. For soft bone, delete last drill.
* For use with drill stops.

(Above photos not to scale)

Implant Instrumentation
continued on next page...

ITL DENTAL

Implant Instrumentation

Non-Adjustable Torque Wrenches



Single Setting Torque Wrenches: 15, 20, 25, 30 and 35 Ncm
15Ncm: GTW 15; 20Ncm: GTW 20; 25Ncm: GTW 25;
30Ncm: GTW 30; 35Ncm: GTW 35
4mm Square Connection

Adjustable Torque Wrench



Adjustable Torque Wrench with Nine Settings:
15, 20, 25, 30, 35, 40, 45, 50 and 60 Ncm
ATWP: with Precise logo ATW: without Precise logo
4mm Square Connection

Prosthetic Kit



Adjustable Torque Wrench and manual knob, with
your choice of up to 6 drivers.

(Above photos not to scale)

Implant Instrumentation
continued on next page...

ITL DENTAL

ITL DENTAL

Implant Instrumentation



Depth Gauge Open End Wrench: DGW

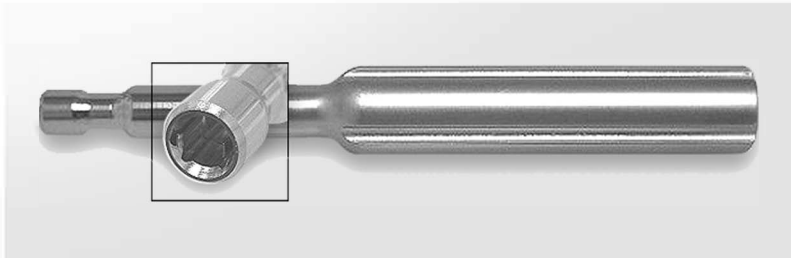

4mm Square Screw Driver Handle: ISIH

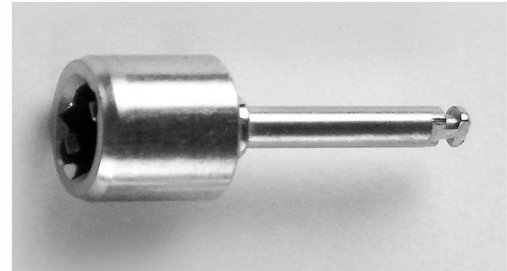

Implant Mount Driver-
IMDSN



4mm Ratchet Wrench: RWA

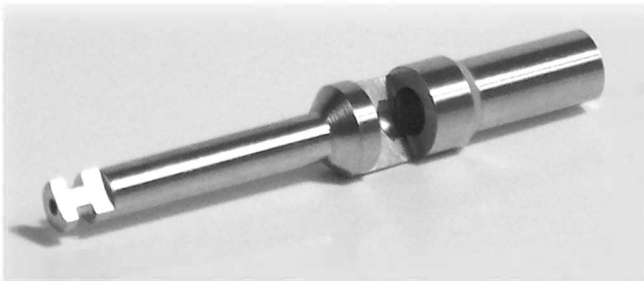

Drill Extension: DEXI



Direction Indicators:
DI 1823

(Above photos not to scale)

Implant Instrumentation
continued on next page...

ITL DENTAL

Implant Instrumentation

Implant Drivers, Extensions & Adaptors

SHAFT LENGTHS:

SHORT: 6.4mm

LONG: 12.7mm

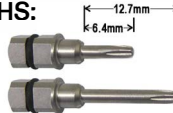

TIPS	HEX DRIVERS	SPECS	TIPS	HEX DRIVERS	SPECS	TIPS	SPECIALTY DRIVERS	SPECS
		.035 Hex Tapered Short: HCT Long: HCLT			.070 Hex Long: HTSI			.048 / .050 Hex Short: HNHTL Long: HNHTL
		.035 Hex Short: HC Long: HCL			.080 Hex Short: HU Long: HUL			Torx Short: PROC-S Long: PROC-L NobelBiocare
		.040 Hex Tapered Short: HSM Long: HSML			2.5mm Hex Short: H25S Long: H25L			Torx Short: ITIS Long: ITL ITI/Straumann
		.048 Hex Tapered Short: HNT Long: HNLT			Hex Driver for internal Hex Long: IHDL			4mm Square Head Triangle Driver Short: TRIS
		.050 Hex Tapered Short: HTT Long: HTLT			Hex Driver for internal Hex Short: IHDS			4mm Square Head Triangle Driver Long: TRIL
		.052 Hex Tapered Short: HT2SMT Long: HT2SMLT			Implant Driver 5.7mm internal Hex Long: IHD5L			Female Driver .080 Hex Short: HFD
		.062 Hex Short: HS Long: HSL			Implant Driver 5.7mm internal Hex Short: IHD5S			TG Post for 3i/ITI/Straumann TGDN
								Mini Implant Driver Short MIDS
								Mini Implant Driver Long MIDL

(Product photos not to scale)

To order call: 800.277.0073
or contact us at: sales@itildental.com
For additional implant-related product information, visit our website at: www.itildental.com

Implant Instrumentation

Implant Drivers, Extensions & Adaptors

SHAFT LENGTHS:

SHORT: 6.4mm

LONG: 12.7mm

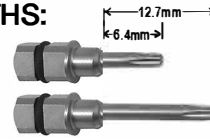

TIPS	LATCH STYLE DRIVERS	SPECS	TIPS	LATCH STYLE DRIVERS	SPECS	TIPS	ADAPTORS	SPECS	
		2.5mm Latch Style Hex Driver Short: H25LS Long: H25LL			Implant Latch Driver for Internal Hex Long: IHDRAL			NA NobelBiocare Torque Wrench Adaptor	
		Latch Style Torx Driver NobelBiocare Short: PROCLSS Long: PROCLSL			Implant Latch Driver for Internal Hex Short: IHDRAS			ITIA ITI/Straumann Torque Wrench Adaptor	
		.040 Latch Style, Tapered Hex Driver H40FA			Implant Latch Driver for 5.7mm Internal Hex Long: IHD5RAL			LS Latch to Square Adaptor	
		.048 Latch Style, Tapered Hex Driver T10/24			Implant Latch Driver for 5.7mm Internal Hex Short: IHD5RAS	MANUAL KNOB		SPECS	
		.050 Latch Style, Tapered Hex Driver Short: HTRAS Long: HTRAL	TIPS		SQUARE DRIVERS	SPECS		Manual Knob TK	
		4mm Latch Style Triangle Driver TRIA			.050 Square Driver, Long: CERL Short: CERS	TIPS		EXTENSIONS	SPECS
		Latch Style Torx Driver ITI/Straumann Short: ITILSS Long: ITILSL			.050 Latch Style, Square Driver T17/24			3/8" Extension EX	
			TIPS		SLOT DRIVERS	SPECS			5/8" Extension EXL
					0.017 Slot Driver Short: SN Long: SNL				

To order call: 800.277.0073
or contact us at: sales@itldental.com
For additional implant-related product information, visit our website at: www.itldental.com

(Product photos not to scale)

Implant Instrumentation

Bone Expander Kit

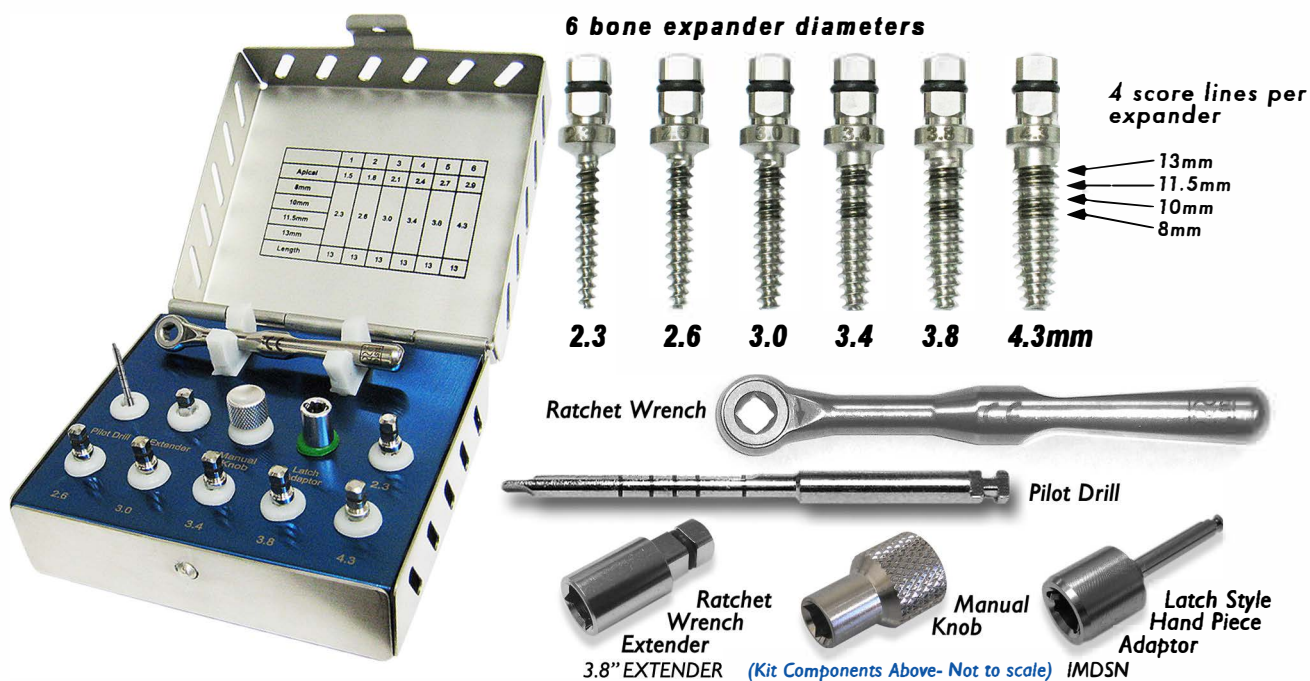

An Alternative to Osteotomes

Bone expander drills are an alternative to osteotomes for the expansion and condensing of the atrophic mandible and maxilla in preparation for dental implant insertions. Expanders are also an alternative to the maxillary sinus elevation technique.

Surgical Drama Decreased

Expanders are driven into the bone with a ratchet wrench or low speed hand piece. This decreases the surgical trauma of osteotomes. Bone expanders improve the clinical success by improving stability, maintaining bone density and increasing fixation.

What the Kit Includes

The Bone Expander Kit from ITL Dental includes 6 expanders, a ratchet wrench, a pilot drill, a ratchet wrench extender, a hand piece latch adaptor and a manual knob for finger usage. The kit is autoclavable.

Product code: BEK

Implant Instrumentation

Basic Surgical Drilling Kit



**The ITL DENTAL
Basic Surgical Drilling Kit
Product Code: SKK**



The Surgical Drilling Kit shown here includes a Ratchet Wrench, 1.25mm Hex Driver, Motor Driver, Manual Knob, Pilot Drill, 2.5mm Hex Driver, Long, 2.5mm Hex Driver, Short, 2 Paralleling Pins, with the following Drills: 2.3/2.0; 2.8/2.3; 3.4/2.8; 3.8/3.4; 4.4/3.8; 4.8/4.4 and 5.4/4.8mm Drills. The Kit is fully autoclaveable and constructed of high-grade stainless steel.

Autoclavable:

This kit may be autoclaved. Follow the sterilizer manufacturer’s recommended procedure while observing the following cautions:

Caution:

- **Do not** exceed 275° (175°C)
 - **Do not** submerge in any solution
 - **Do not** use ultrasonic devices
 - **Do not** autoclave for extended periods of time (i.e. overnight).
- Extended autoclaving should not be confused with repeated autoclaving. Repeated autoclaving will not harm the product.

ITL DENTAL

Implant Instrumentation

Advanced Surgical Drilling Kit



**The
Advanced
Surgical Drilling Kit
Product Code: SKLK**

The Advanced Surgical Drilling Kit shown here includes: Ratchet Wrench, Straight Handle, Drill Extension, Implant Mount Driver, Thumb Knob, Long and Short .048 Hex Driver, Long and Short .050 Hex Driver, Long and Short 2.5mm Hex Driver, 4, Direction Indicators, Pilot Drill, and 7, Surgical Drills: 2.3/2.0, 2.8/2.3, 3.4/2.8, 3.8/3.4, 4.4/3.8, 4.8/4.4, and 5.4/4.8. The Kit is autoclaveable.

Autoclaving:

This kit may be autoclaved. Follow the sterilizer manufacturer's recommended procedure while observing the following cautions:

Caution:

- **Do not** exceed 275° (175°C)
 - **Do not** submerge in any solution
 - **Do not** use ultrasonic devices
 - **Do not** autoclave for extended periods of time (i.e. overnight).
- Extended autoclaving should not be confused with repeated autoclaving. Repeated autoclaving will not harm the product.

Prosthetic Catalog Index

Internal Hex

Implant Items		1 - 17
Section 1	OLS	19 - 20
Section 2	MLS SYSTEM	21 - 22
Section 3	MLS UNIT RESTORATION	23 - 24
Section 4	BALL ATTACHMENT	25, 26, 27
Section 5	TEMPORARY ABUTMENTS	28
Section 6	TITANIUM ABUTMENTS	29, 30, 31, 32
Section 8	CASTING ABUTMENTS	33
Section 9	ANALOG	34
Section 10	3D SCANNING INTERFACE	35
Section 11	HEALING CAP	36
Section 12	PROSTHETIC SCREWS	37
Section 13	TRANSFER	38

STRAIGHT OLS ABUTMENT SYSTEM

Over Denture Attachment in connection with implants

OLS ABUTMENT SYSTEM



OLS ABUTMENT SYSTEM MINOR - RETAINED OVER DENTURE ABUTMENTS

Abutment bases in connection with implants
3.5 Platform



Cat. No.	WCM-0000	WCM-0010	WCM-0020	WCM-0030	WCM-0040	WCM-0050
Designation	0mm Aesthetic Height	1mm Aesthetic Height	2mm Aesthetic Height	3mm Aesthetic Height	4mm Aesthetic Height	5mm Aesthetic Height

for FULL SET add SPE to Cat No.

OLS ABUTMENT SYSTEM - MINOR SET PEEK

Abutment bases with peek attachment and housing covers
3.5 Platform

FULL SET



Cat. No.	WCM-0000 - SPE	WCM-0010 - SPE	WCM-0020 - SPE	WCM-0030 - SPE	WCM-0040 - SPE	WCM-0050 - SPE
Designation	0mm Aesthetic Height	1mm Aesthetic Height	2mm Aesthetic Height	3mm Aesthetic Height	4mm Aesthetic Height	5mm Aesthetic Height



OLS ABUTMENT SYSTEM - ACCESSORIES



Cat. No.	WCH-5628	WCH-4823	WCP-2348-H	WCPS-2348-H	WCP-2348	SCH-8540	TWC-1105	WCT-900	AWC-1301
Designation	STAINLESS STEEL HOUSING COVER	STAINLESS STEEL HOUSING	Hard Housing PEEK Attachment	Soft Housing PEEK Attachment	DIRECT PEEK Attachment	SILICON Sealed RING	TRANSFER for OLS	OLS ABUTMENT SYSTEM Tool	ANALOG for OLS

ANGULAR OLS ABUTMENT SYSTEM CONCEPT 9°, 18°, 30°

OLS Over Denture Attachment - SETS



OLS ABUTMENT SYSTEM ON MLS SYSTEM

9° OLS ABUTMENT SYSTEM ANGULAR MLS SYSTEM CONCEPT

OLS Angular Over Denture Attachment - SET



Cat. No.	WCA-0920 - M	WCA-0930 - M	WCA-0940 - M	WCA-0950 - M
Designation	9° OLS angular MLS System 2 mm Height	9° OLS angular MLS System 3 mm Height	9° OLS angular MLS System 4 mm Height	9° OLS angular MLS System 5 mm Height



Cat. No.	OLH 0035
Designation	Orienting Lead Holder



18° OLS ABUTMENT SYSTEM ANGULAR MLS SYSTEM CONCEPT

OLS Angular Over Denture Attachment - SET



Cat. No.	WCA-1820 - M	WCA-1830 - M	WCA-1840 - M	WCA-1850 - M
Designation	18° OLS angular MLS System 2 mm Height	18° OLS angular MLS System 3 mm Height	18° OLS angular MLS System 4 mm Height	18° OLS angular MLS System 5 mm Height

30° OLS ABUTMENT SYSTEM ANGULAR MLS SYSTEM CONCEPT

OLS Angular Over Denture Attachment - SET



Cat. No.	WCA-3020 - M	WCA-3030 - M	WCA-3040 - M	WCA-3050 - M
Designation	30° OLS angular MLS System 2 mm Height	30° OLS angular MLS System 3 mm Height	30° OLS angular MLS System 4 mm Height	30° OLS angular MLS System 5 mm Height

Designation info for Angular MLS System Adaptors:

Internal Hex:

-  3.5 platform = WCA-... - M
-  4.5 platform = WCA-... - W

ITL DENTAL

Prosthetic Catalog

ANGULAR MLS SYSTEM CONCEPT 9°,18°,30° MLS Unit Items Over Denture Attachment

MLS SYSTEM

ESTHETIC MINOR UNIT - System Adaptor
Angular MLS System Adaptor 9°,18°,30°
3.5 Platform

WIDE UNIT - System Adaptor
Angular MLS System Adaptor 9°,18°,30°
4.5 Platform



Cat. No.	EMU-0910	EMU-1810	EMU-3010
Designation	9° ANGLE MLS SYSTEM Adaptor	18° ANGLE MLS SYSTEM Adaptor	30° ANGLE MLS SYSTEM Adaptor



Cat. No.	OLH 0035
Designation	Orienting Lead Holder



Cat. No.	EWU-0910	EWU-1810	EWU-3010
Designation	9° ANGLE MLS SYSTEM Adaptor	18° ANGLE MLS SYSTEM Adaptor	30° ANGLE MLS SYSTEM Adaptor

ANGLE AND HEIGHT GAUGE



Cat. No.	GAHM-00	GAHM-09	GAHM-18	GAHM-30	GAHM-SET
Designation	Straight gauge	9° Angle gauge	18° Angle gauge	30° Angle gauge	Set include full range of gauges

OLS ABUTMENT SYSTEM CONNECTION OLS Connection for MLS System Concept



Cat. No.	WCC-0020	WCC-0030	WCC-0040	WCC-0050
Designation	2 mm CONNECTION MLS SYSTEM OLS	3 mm CONNECTION MLS SYSTEM OLS	4 mm CONNECTION MLS SYSTEM OLS	5 mm CONNECTION MLS SYSTEM OLS



OLS

OLS ABUTMENT SYSTEM - ACCESSORIES



Cat. No.	WCH-5628	WCH-4823	WCP-2348-H	WCP-2348-H	WCP-2348	SCH-8540	TWC-1105	WCT-900	AWC-1301
Designation	STAINLESS STEEL HOUSING COVER	STAINLESS STEEL HOUSING	Hard Housing PEEK Attachment	Soft Housing PEEK Attachment	DIRECT PEEK Attachment	SILICON Sealed RING	TRANSFER for OLS	OLS Tool	ANALOG for OLS

ITL DENTAL

Prosthetic Catalog

BALL MLS SYSTEM ANGULAR

Ball attachment connection for MLS System Concept

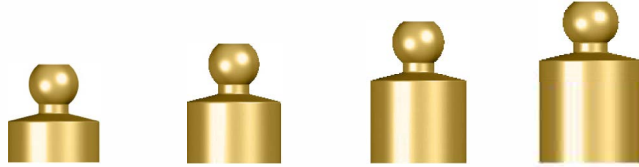

Cat. No.	BMA-0020	BMA-0030	BMA-0040	BMA-0050
Designation	2 mm CONNECTION MLS SYSTEM BALL	3 mm CONNECTION MLS SYSTEM BALL	4 mm CONNECTION MLS SYSTEM BALL	5 mm CONNECTION MLS SYSTEM BALL

BALL Attachment- Accessories



Cat. No.	BHM-5032	BIS-0025
Designation	Stainless Steel Housing	Silicon Insert



MLS SYSTEM UNIT CONNECTION

Screwed in Connection for MLS System Concept

MLS SYSTEM

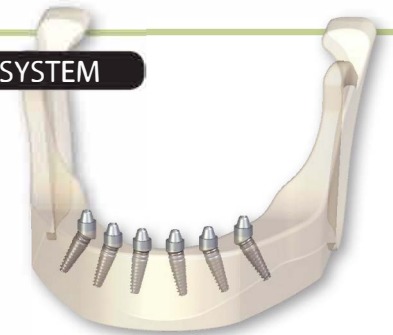

Cat. No.	MUC-0021	MUC-0031	MUC-0041	MUC-0051
Designation	2 mm CONNECTION MLS SYSTEM	3 mm CONNECTION MLS SYSTEM	4 mm CONNECTION MLS SYSTEM	5 mm CONNECTION MLS SYSTEM

MLS-UNIT ACCESSORIES

Cat. No.	PSU-0032	PSU-0050	TSU-1250	TMU-0532	CMU-1006	CMU-1007	TSU-1043	TSU-1055	TMU-1000	TMU-1200	TMU-8005	WQP-001 I	HCC-4550	AMU-1201	TSM-1013	DASM-1040
Designation	Plastic Sleeve screw included	Parallel connection	Titanium Sleeve for Temporary Restoration	Titanium Short Sleeve for Temporary Restoration	Short slim Titanium Sleeve	Long slim Titanium Sleeve L = 80mm	3-D Scanning Device Ti	3-D Scanning Device LAB Ti	Open Tray Short Transfer	Open Tray Transfer	Closed Tray Transfer	Plastic for Closed Tray Transfer	Healing Cap for Multi-Unit	Analog for Multi-Unit	Titanium Sleeve for Welding	Digital Analog for Multi Unit



SMU-4023 Screw for MLS Unit Sleeve
--

NOTE: It is recommended to purchase additional screws.

ITL DENTAL

Prosthetic Catalog

MLS SYSTEM STRAIGHT AESTHETIC ABUTMENTS

Abutments with smooth, non locking surface for MLS-Unit restorations

AESTHETIC MINOR UNIT

Straight MLS-Unit
3.5 platform



Cat. No.	EMU-0011	EMU-0021	EMU-0031	EMU-0041	EMU-0051	EMU-0061
Designation	1mm height	2mm height	3mm height	4mm height	5mm height	6mm height

AESTHETIC WIDE UNIT

Straight MLS-Unit
4.5 platform



Cat. No.	EWU-0011	EWU-0021	EWU-0031	EWU-0041	EWU-0051	EWU-0061
Designation	1mm height	2mm height	3mm height	4mm height	5mm height	6mm height



3
MLS UNIT RESTORATION

Color no. 3
Internal Hex

MLS-UNIT ACCESORIES

Cat. No.	PSU-0032	PSU-0050	TSU-1250	TMU-0532	CMU-1006	CMU-1007	TSU-1043	TSU-1055	TMU-1000	TMU-1200	TMU-8005	WQP-0011	HCC-4550	AMU-1201	TSM-1013	DASM-1040
Designation	Plastic Sleeve screw included	Parallel connection	Titanium Sleeve for Temporary Restoration	Titanium Short Sleeve for Temporary Restoration	Short slim Titanium Sleeve	Long slim Titanium Sleeve L = 80mm	3-D Scanning Device Ti	3-D Scanning Device LAB Ti	Open Tray Short Transfer	Open Tray Transfer	Closed Tray Transfer	Plastic for Closed Tray Transfer	Healing Cap for Multi-Unit	Analog for Multi-Unit	Titanium Sleeve for Welding	Digital Analog for Multi Unit

OVER DENTURE ABUTMENTS

For single tooth restorations

Over Denture Abutments with Hex Locking for single tooth restorations.

AESTHETIC CONNECTION ABUTMENT
with hex for Retention and positioning



Cat. No.	ECA-6005	ECA-6015	ECA-6025
Designation	0.5mm height	1.5mm height	2.5mm height
Related screw	SCS - 3011	SCS - 3012	SCS - 3013

PLASTIC AESTHETIC SLEEVE



Cat. No.	PES-1240	PES-1240 R
Designation	Plastic for ECA hex base	Plastic for ECA round base



ANGULAR MLS SYSTEM CONCEPT 9°,18°,30° MLS Unit Over Denture Attachment

3.5 Platform

9° ANGULAR MLS SYSTEM UNIT CONCEPT
Aesthetic MLS Unit Angular Over Denture Attachment - SET

9°



Cat. No.	EMA-0921-M	EMA-0931-M	EMA-0941-M	EMA-0951-M
Designation	9° Angular MLS 3mm - H	9° Angular MLS 4mm - H	9° Angular MLS 5mm - H	9° Angular MLS 6mm - H

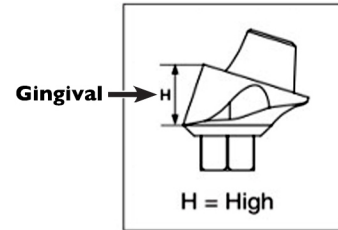

MLS SYSTEM

18° ANGULAR MLS SYSTEM UNIT CONCEPT
Aesthetic MLS Unit Angular Over Denture Attachment

18°

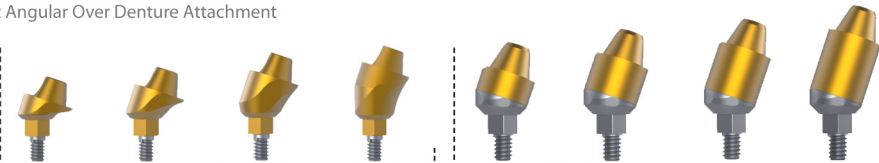

Cat. No.	AMU-1801	AMU-1811	AMU-1821	AMU-1831	EMA-1831-M	EMA-1841-M	EMA-1851-M	EMA-1861-M
Designation	18° Angular MLS 2mm - H	18° Angular MLS 3mm - H	18° Angular MLS 4mm - H	18° Angular MLS 5mm - H	18° Angular MLS 3mm - H	18° Angular MLS 4mm - H	18° Angular MLS 5mm - H	18° Angular MLS 6mm - H



30° ANGULAR MLS SYSTEM UNIT CONCEPT
Aesthetic MLS Unit Angular Over Denture Attachment

30°

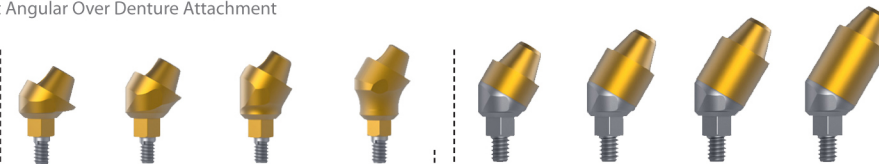

Cat. No.	AMU-3001	AMU-3011	AMU-3021	AMU-3031	EMA-3031-M	EMA-3041-M	EMA-3051-M	EMA-3061-M
Designation	30° Angular MLS 3mm - H	30° Angular MLS 4mm - H	30° Angular MLS 5mm - H	30° Angular MLS 6mm - H	30° Angular MLS 4mm - H	30° Angular MLS 5mm - H	30° Angular MLS 6mm - H	30° Angular MLS 7mm - H

3 MLS SYSTEM RESTORATION

Color no. 3
Internal Hex

4.5 Platform

18° ANGULAR MLS SYSTEM UNIT CONCEPT
Aesthetic MLS Unit Angular Over Denture Attachment

18°

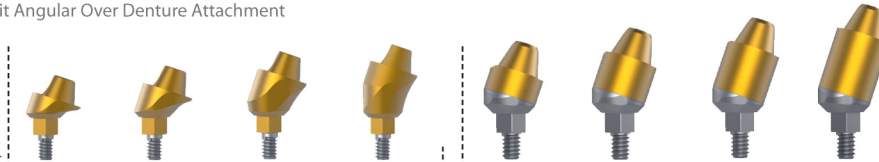

Cat. No.	AWU-1801	AWU-1811	AWU-1821	AWU-1831	EMA-1831-W	EMA-1841-W	EMA-1851-W	EMA-1861-W
Designation	18° Angular MLS 2mm - H	18° Angular MLS 3mm - H	18° Angular MLS 4mm - H	18° Angular MLS 5mm - H	18° Angular MLS 3mm - H	18° Angular MLS 4mm - H	18° Angular MLS 5mm - H	18° Angular MLS 6mm - H



30° ANGULAR MLS SYSTEM UNIT CONCEPT
Aesthetic MLS Unit Angular Over Denture Attachment

30°

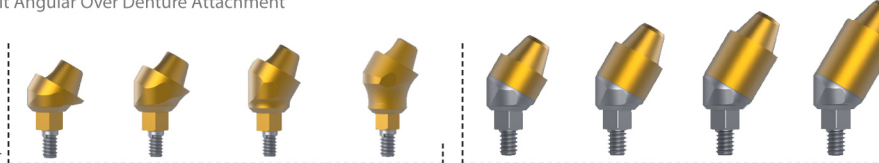

Cat. No.	AWU-3001	AWU-3011	AWU-3021	AWU-3031	EMA-3031-W	EMA-3041-W	EMA-3051-W	EMA-3061-W
Designation	30° Angular MLS 3mm - H	30° Angular MLS 4mm - H	30° Angular MLS 5mm - H	30° Angular MLS 6mm - H	30° Angular MLS 4mm - H	30° Angular MLS 5mm - H	30° Angular MLS 6mm - H	30° Angular MLS 7mm - H

Over Denture Ball Attachment in Connection with Implants

BALL MINOR STRAIGHT 3.5 Platform Dia. 4 mm



Cat. No.	BMS-4010	BMS-4020	BMS-4030	BMS-4040	BMS-4050	BMS-4060
Description	without cap 1mm height	without cap 2mm height	without cap 3mm height	without cap 4mm height	without cap 5mm height	without cap 6mm height

BALL MINOR SET -...- SILICON 3.5 Platform Dia. 4 mm

FULL SET



Cat. No.	BMT-0010-S	BMT-0020-S	BMT-0030-S	BMT-0040-S	BMT-0050-S	BMT-0060-S
Description	with stainless housing & silicon insert	with stainless housing & silicon insert	with stainless housing & silicon insert	with stainless housing & silicon insert	with stainless housing & silicon insert	with stainless housing & silicon insert

BALL HOUSING MINOR / BALL INSERT SILICON



Cat. No.	BHM-5032	BIS-0025
Description	Stainless housing	Silicon insert



ITL DENTAL

Prosthetic Catalog

BALL WIDE STRAIGHT 4.5 Platform



Cat. No.	BWS-4010	BWS-4020	BWS-4030	BWS-4040	BWS-4050	BWS-4060
Description	without cap 1mm height	without cap 2mm height	without cap 3mm height	without cap 4mm height	without cap 5mm height	without cap 6mm height

BALL WIDE SET --- SILICON 4.5 Platform



Cat. No.	BWT-0010-S	BWT-0020-S	BWT-0030-S	BWT-0040-S	BWT-0050-S	BWT-0060-S
Description	with stainless housing & silicon insert	with stainless housing & silicon insert	with stainless housing & silicon insert	with stainless housing & silicon insert	with stainless housing & silicon insert	with stainless housing & silicon insert

BALL HOUSING MINOR / BALL INSERT SILICON



Cat. No.	BHM-5032	BIS-0025
Description	Stainless housing	Silicon insert



ITL DENTAL

Prosthetic Catalog

ANGULAR MLS SYSTEM CONCEPT 9°,18°,30°

Angular Ball Attachment - Set

9° BALL MINOR ANGULAR MLS SYSTEM CONCEPT

3.5 Platform



Cat. No.	BMA-0920-S	BMA-0930-S	BMA-0940-S	BMA-0950-S
Designation	with stainless housing & silicon insert 2mm height	with stainless housing & silicon insert 3mm height	with stainless housing & silicon insert 4mm height	with stainless housing & silicon insert 5mm height

18° BALL MINOR ANGULAR MLS SYSTEM CONCEPT

3.5 Platform



Cat. No.	BMA-1820-S	BMA-1830-S	BMA-1840-S	BMA-1850-S
Designation	with stainless housing & silicon insert 2mm height	with stainless housing & silicon insert 3mm height	with stainless housing & silicon insert 4mm height	with stainless housing & silicon insert 5mm height

Designation info for
Angular MLS System Adaptors:

Internal Hex:
3.5 platform = EMA-... - M
4.5 platform = EMA-... - W

30° BALL MINOR ANGULAR MLS SYSTEM CONCEPT

3.5 Platform



Cat. No.	BMA-3020-S	BMA-3030-S	BMA-3040-S	BMA-3050-S
Designation	with stainless housing & silicon insert 2mm height	with stainless housing & silicon insert 3mm height	with stainless housing & silicon insert 4mm height	with stainless housing & silicon insert 5mm height

BALL HOUSING MINOR / BALL INSERT SILICON



Cat. No.	BHM-5032	BIS-0025
Designation	Stainless housing	Silicon insert



Cat. No.	OLH 0035
Designation	Orienting Lead Holder

4 BALL ATTACHMENT

Color no. 4
Internal Hex

ITL DENTAL

Prosthetic Catalog

TEMPORARY AESTHETIC ABUTMENTS

Includes a Retaining Screw

Abutments for temporary restoration made of biocompatible material PEEK. Polyether ether Ether Ketone is a colorless organic Thermoplastic polymer, proven to provide long term service.

STRAIGHT LEVEL MINOR - PEEK 3.5 Platform



Cat. No.	SLM-1110P	SLM-1220P	SLM-1330P
Designation	1mm shoulder	2mm shoulder	3mm shoulder

TEMPORARY TITANIUM ABUTMENT 3.5 Platform



Cat. No.	SMT-1210	SMT-1210R
Designation	Engaging	Non Engaging



ANGULAR CURVE MINOR - PEEK Platform 15° 3.5



Cat. No.	ACM-1115-10P	ACM-1215-20P	ACM-1215-30P	ACM-1315-40P
Designation	1mm Aesthetic shoulder	2mm Aesthetic shoulder	3mm Aesthetic shoulder	4mm Aesthetic shoulder

ANGULAR CURVE MINOR - PEEK 3.5 Platform 25°



Cat. No.	ACM-1125-10P	ACM-1225-20P
Designation	1mm Aesthetic shoulder	2mm Aesthetic shoulder

IMMEDIATE TEMPORARY CONICAL for immediate loading restoration 3.5 Platform



Cat. No.	ITC-0010	ITC-0020	ITC-0030	ITC-0040	ITC-0050	ITC-0060	CCP-00
Designation	1mm Aesthetic shoulder	2mm Aesthetic shoulder	3mm Aesthetic shoulder	4mm Aesthetic shoulder	5mm Aesthetic shoulder	6mm Aesthetic shoulder	PEEK Cover non engaging

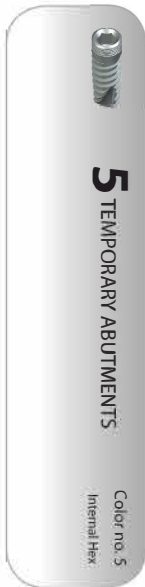

ITL DENTAL

Prosthetic Catalog

STRAIGHT AESTHETIC ABUTMENTS

Includes a Retaining Screw

Ultra Slim Abutments are designed to be used in cases where the gaps between the implants are too narrow for standard abutments.

STRAIGHT CURVE MINOR

3.5 platform



Part No.	SCM-1110	SCM-1220	SCM-1330	SCM-1440
Description	Aesthetic Shoulder 1mm height	Aesthetic Shoulder 2mm height	Aesthetic Shoulder 3mm height	Aesthetic Shoulder 4mm height

STRAIGHT LEVEL MINOR WITH HEX

platform 3.5



Part No.	SLM-1116	SLM-1226	SLM-1336
Description	Straight Shoulder 1mm height	Straight Shoulder 2mm height	Straight Shoulder 3mm height

STRAIGHT LEVEL MINOR

3.5 platform



Part No.	SLM-1110	SLM-1220	SLM-1330
Description	Straight Shoulder 1mm height	Straight Shoulder 2mm height	Straight Shoulder 3mm height

STRAIGHT LEVEL MINOR WITH GROOVES

platform 3.5



Part No.	SLM-1110-G	SLM-1220-G	SLM-1330-G
Description	Straight Shoulder 1mm height	Straight Shoulder 2mm height	Straight Shoulder 3mm height

STRAIGHT SLIM MINOR

3.5 platform



Part No.	SSM-0006	SSM-0008	SSM-0010
Description	Ultra Slim Abutment 6mm height	Ultra Slim Abutment 8mm height	Ultra Slim Abutment 10mm height

STRAIGHT MINOR

platform 3.5



Part No.	STM-0910	STM-1110	STM-1310	STM-1120
Description	Standard Abutment 9mm height	Standard Abutment 11mm height	Standard Abutment 13mm height	Thick Abutment 11mm height

STRAIGHT CURVE WIDE

4.5 platform



Part No.	SCW-1110	SCW-1220	SCW-1330	SCW-1440
Description	Aesthetic Shoulder 1mm height	Aesthetic Shoulder 2mm height	Aesthetic Shoulder 3mm height	Aesthetic Shoulder 4mm height

STRAIGHT WIDE

platform 4.5



Part No.	STW-1110
Description	Standard Abutment 11mm height

STRAIGHT LEVEL WIDE

4.5 platform



Part No.	SLW-1110	SLW-1220	SLW-1330
Description	Straight Shoulder 1mm height	Straight Shoulder 2mm height	Straight Shoulder 3mm height



ITL DENTAL

Prosthetic Catalog

ANGULAR AESTHETIC ABUTMENTS

Includes a Retaining Screw

SPECIFICATIONS

- Includes the Prosthetic Screw
- Installs with 0.050 hex drivers (1.27mm)
- Non-rotational design for standard, internal-hex implants
- Made of Commercial grade 5 Titanium alloy (ASTM-F-136 02A COND A)



ANGULAR CURVE MINOR 3.5 Platform 15°



Cat. No.	ACM-1115-10	ACM-1215-20	ACM-1215-30	ACM-1315-40
Designation	1mm Aesthetic shoulder	2mm Aesthetic shoulder	3mm Aesthetic shoulder	4mm Aesthetic shoulder



ANGULAR CURVE WIDE 4.5 Platform 15°



Cat. No.	ACW-1115-10	ACW-1215-20
Designation	1mm Aesthetic shoulder	2mm Aesthetic shoulder



ANGULAR CURVE MINOR 3.5 Platform 25°



Cat. No.	ACM-1125-10	ACM-1225-20	ACM-1325-30	ACM-1425-40
Designation	1mm Aesthetic shoulder	2mm Aesthetic shoulder	3mm Aesthetic shoulder	4mm Aesthetic shoulder



STRAIGHT & ANGLED CERVICAL CONTOURED ABUTMENTS

Includes a Retaining Screw

SPECIFICATIONS

- Installs with 0.050 hex drivers (1.27mm)
- Non-rotational design for standard, internal-hex implants
- Made of Commercial grade 5 Titanium alloy (ASTM-F-136 02A COND A)



STRAIGHT CERVICAL CONTOUR

3.5 Platform



Cat. No.	SCCM-1220	SCCM-1330	SCCM-1440
Designation	Straight Aesthetic Abutment 2mmH	Straight Aesthetic Abutment 3mmH	Straight Aesthetic Abutment 4mmH

STRAIGHT CERVICAL CONTOUR

4.5 Platform



Cat. No.	SCCW-1220	SCCW-1330	SCCW-1440
Designation	Straight Aesthetic Abutment 2mmH	Straight Aesthetic Abutment 3mmH	Straight Aesthetic Abutment 4mmH

6 CERVICAL CONTOUR ABUTMENTS

ANGULAR CERVICAL CONTOUR

3.5 Platform 15°



Cat. No.	ACCM-1215-20	ACCM-1315-30	ACCM-1415-40
Designation	15° Aesthetic Abutment 2mmH	15° Aesthetic Abutment 3mmH	15° Aesthetic Abutment 4mmH

ANGULAR CERVICAL CONTOUR

3.5 Platform 25°



Cat. No.	ACCM-1225-20	ACCM-1325-30	ACCM-1425-40
Designation	25° Aesthetic Abutment 2mmH	25° Aesthetic Abutment 3mmH	25° Aesthetic Abutment 4mmH

ANGULAR SMOOTH MINOR - LEAF



Cat. No.	ASM-0915 - LF	ASM-1115 - LF
Designation	Chopped edge	Chopped edge



ANGULAR SMOOTH MINOR - LEAF 3.5 Platform 25°

Ultra Slim and **LEAF** treatment are for front teeth



Cat. No.	ASM-0925 - LF	ASM-1125 - LF
Designation	Chopped edge	Chopped edge

ANGULAR SMOOTH MINOR 3.5 Platform 15°



Cat. No.	ASM-0915	ASM-1115	ASM-1315
Designation	Smooth shape	Smooth shape	Smooth shape

ANGULAR SMOOTH THIN 3.5 Platform 15° & 25°



Cat. No.	AST-1115	AST-1125
Designation	Ultra Slim 15°	Ultra Slim 25°

ANGULAR SMOOTH WIDE 4.5 Platform 15°



Cat. No.	ASW-1115
Designation	Smooth shape

ANGULAR SMOOTH MINOR 3.5 Platform 25°



Cat. No.	ASM-0925	ASM-1125	ASM-1325
Designation	Smooth shape	Smooth shape	Smooth shape

PLASTIC ABUTMENTS FOR CASTING

PLASTICS STRAIGHT FOR CASTING 3.5 / 4.5 Platform



Cat. No.	PSM-0013	PSW-0013	PSM-6013	PSW-6013
Designation	Round Base	Round Base wide Cylinder	Hex Base	Hex Base wide Cylinder



8 CASTING ABUTMENTS

Color no. 8
Internal Hex

The Titanium / Plastic Abutments are for Investment and casting following conventional crown and bridge techniques. The Titanium / Plastic Abutments combine precision machined interface between the implant and the Abutment with the convenience of a castable plastic sleeve.

TITANIUM PLASTIC ABUTMENT 3.5 Platform



Cat. No.	TPA-1420	TPA-1420 R
Designation	Hex Base	Round Base

TITANIUM PLASTIC ABUTMENT 4.5 Platform



Cat. No.	TPA-1420 W	TPA-1420 WR
Designation	Hex Base wide platform	Round Base wide platform

CERVICAL CONTOURED PLASTIC ABUTMENTS

3.5 Platform, 2mm Shoulder



Cat. No.	CPA-1420	CPA-1420-R
Designation	Hex Base	Round Base

3.5 Platform, 3mm Shoulder



Cat. No.	CPA-1430	CPA-1430-R
Designation	Hex Base H= 3.0 mm	Round Base H= 3.0 mm

4.5 Platform, 2mm Shoulder



Cat. No.	CPA-1420-W	CPA-1420-WR
Designation	Hex Base Wide Platform	Round Base Wide Platform

ITL DENTAL

Prosthetic Catalog

Analogs are used for the fabrication of a master model.
They are replicas of the implant. All analogs are made of high grade stainless steel.

ANALOG STAINLESS



Cat. No.	AMS-1201	AWS-1201	A57S	AMB-1201
Designation	Stainless body 3.5 Regular Platform	Stainless body 4.5 Wide Platform	5.7 Analog Internal Hex Implant	Analog for Ball Attachment

ANALOG MLS SYSTEM

9 ANALOG

Color no. 9
Internal Hex



MLS SYSTEM

Cat. No.	AMU-1201
Designation	Analog for Multi-Unit

ANALOG FOR OLS ABUTMENT SYSTEM



OLS ABUTMENT SYSTEM

Cat. No.	AWC-1301
Designation	Analog for OLS Abutment System

ITL DENTAL

Prosthetic Catalog



Cat. No.	SBT - 1016	SBT - 1056	SDAS - 1057
Designation	3D Scan Body for TiBase 10mm	3D Scan Body for TiBase / Long 13mm	Digital Analog for Model

3.5 Platform - Non-Rotational

SMS - 6031 H=01 CadCam TiBase Non-rotational	SMS - 6032 H=02 CadCam TiBase Non-rotational	SMS - 6033 H=03 CadCam TiBase Non-rotational	SMS - 6034 H=04 CadCam TiBase Non-rotational

3.5 Platform - Rotational

SMS - 0031 H=01 CadCam TiBase Rotational	SMS - 0032 H=02 CadCam TiBase Rotational	SMS - 0033 H=03 CadCam TiBase Rotational	SMS - 0034 H=04 CadCam TiBase Rotational

4.5 Platform

SWS - 6030 	SWS - 0030
CadCam TiBase wide Non-rotational	CadCam TiBase wide Rotational

NOTE: Use screw SCS - 3095 or SCP - 2580 for scanning abutments.



ITL DENTAL

Prosthetic Catalog

Healing caps are used to maintain access through tissue during the healing phase. They are available in variety of heights and diameters to accommodate tissue depth.

HEALING CAP MINOR 3.5 Ultra Slim Platform



Cat. No.	HCM-3720S	HCM-3730S	HCM-3740S	HCM-3750S	HCM-3760S	HCM-3770S
Designation	Dia. 3.7 mm 2mm height	Dia. 3.7 mm 3mm height	Dia. 3.7 mm 4mm height	Dia. 3.7 mm 5mm height	Dia. 3.7 mm 6mm height	Dia. 3.7 mm 7mm height

* Recommended for narrow spaces

HEALING CAP MINO 3.5 Slim Platform



Cat. No.	HCM-4020S	HCM-4030S	HCM-4040S	HCM-4050S	HCM-4060S	HCM-4070S
Designation	Dia. 4.6 mm 2mm height	Dia. 4.6 mm 3mm height	Dia. 4.6 mm 4mm height	Dia. 4.6 mm 5mm height	Dia. 4.6 mm 6mm height	Dia. 4.6 mm 7mm height

* Recommended for narrow spaces

HEALING CAP MINO 3.5 Normal Platform

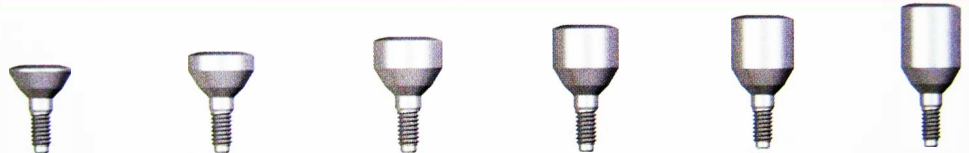

Cat. No.	HCM-5020S	HCM-5030S	HCM-5040S	HCM-5050S	HCM-5060S	HCM-5070S
Designation	Dia. 5 mm 2mm height	Dia. 5 mm 3mm height	Dia. 5 mm 4mm height	Dia. 5 mm 5mm height	Dia. 5 mm 6mm height	Dia. 5 mm 7mm height

* Recommended for angular restoration

HEALING CAP WIDE 4.5 Wide Platform

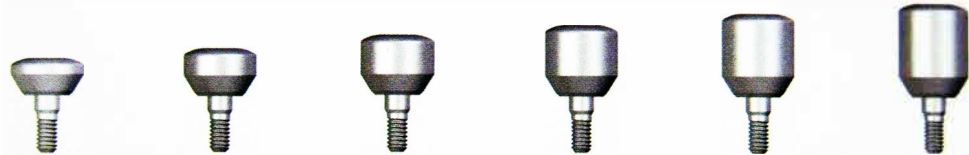

Cat. No.	HCW-6030S	HCW-6040S	HCW-6050S	HCW-6060S	HCW-6070S	HCW-6080S
Designation	Dia. 6 mm 3mm height	Dia. 6 mm 4mm height	Dia. 6 mm 5mm height	Dia. 6 mm 6mm height	Dia. 6 mm 7mm height	Dia. 6 mm 8mm height

HEALING CAP WIDE 5.7 Wide Platform



Cat. No.	HCW-6530S	HCW-6550S
Designation	Dia. 6.6 mm 3mm height	Dia. 6.6 mm 5mm height



NOTE: Cervical contoured healing caps are available in the 40XX, 50XX series and HCW-6030S, 6040S, and 6050S. For cervical contoured, delete the S at the end of the product code.

SCREWS FOR ABUTMENTS



Cat. No.	SCA - 2385	SCS - 3095	SMU - 4023
Description	For Angular Abutment	For Straight Abutment	For MLS Unit Sleeve

SCREWS FOR OVER DENTURE ABUTMENTS



Cat. No.	SCS - 3011	SCS - 3012	SCS - 3013
Description	For Over denture Abutment ECA-6005	For Over Denture Abutment ECA-6015	For Over Denture Abutment ECA-6025

SCREWS FOR OPEN TRAY TRANSFER



Cat. No.	SCT - 3014	SCT - 3018	SCT - 3023
Description	For MLS Unit Transfer	For Short Transfer Open Tray	For Transfer - Open Tray

SCREW FOR PLASTIC ABUTMENTS



Cat. No.	SCP-2580	SCA-2565
Description	For Straight Plastic Abutment	For Angular Peek Abutment

SCREW FOR CLOSE TRAY TRANSFER



Cat. No.	SCT - 2213
Description	For Close tray Transfer



TRANSFER IMPRESSION COPING

Includes a Retaining Screw

TRANSFER STAINLESS
open tray Transfer
3.5 Platform



Cat. No.	TMS-1301	TSS - 1001	TMS-1001
Designation	Stainless body Long Design	Stainless body Slim design	Stainless body Short Design

TRANSFER WIDE STAINLESS
Open Tray Transfer
4.5 Platform



Cat. No.	TWS-1301
Designation	Stainless body Long Design

13 TRANSFER

Color no. 13
Internal Hex

TRANSFER CLOSED
Closed-tray CONCAVE Transfer
3.5 Platform



Cat. No.	TMCC-0930	TMCC-0950
Designation	Titanium Body CONCAVE H= 3.0 mm	Titanium Body CONCAVE H= 5.0 mm

TRANSFER CLOSED
Closed-tray Transfer
3.5 Platform



Cat. No.	TMC-100003	TMC-100004
Designation	Long Transfer L = 6.0 mm Titanium Body	Long Transfer L = 7.5 mm Titanium Body

TRANSFER CLOSED
Closed-tray Transfer Abutment
3.5 Platform



Cat. No.	TMC-0910	TMC-0920	TMC-0930	TMC-0940	TMC-0950
Designation	Titanium body 1mm Aesthetic shoulder	Titanium body 2mm Aesthetic shoulder	Titanium body 3mm Aesthetic shoulder	Titanium body 4mm Aesthetic shoulder	Titanium body 5mm Aesthetic shoulder

TMP - 0010 Cap included with closed transfers.

TRANSFER MATCHED PLASTIC
Closed-tray Transfer Plastic Cap



Cat. No.	TMP-0008	TMP-0010
	low level plastic cap	high level plastic cap

TRANSFER WIDE CLOSED
Closed-tray Transfer Abutment
4.5 Platform



Cat. No.	TWC-0910	TWC-0920	TWC-0930	TWC-0940	TWC-0950
Designation	Titanium body 1mm Aesthetic shoulder	Titanium body 2mm Aesthetic shoulder	Titanium body 3mm Aesthetic shoulder	Titanium body 4mm Aesthetic shoulder	Titanium body 5mm Aesthetic shoulder

* Plastic cap included

Titanium body
Tin coated



TRANSFER CLOSED
Closed-tray Transfer
3.5 Platform



Cat. No.	TMC-0900
Designation	Stainless body